

## HERZZIEGEL

The unmistakable interlocking tile.

- Traditional model with snow stop effect

### TECHNICAL DATA

Size (appr.)	230 x 420 mm
Covering width min. approx.	205 mm
Covering width on av. approx.	207 mm
Max. coverage width (approx.)	209 mm
Min. gauge (approx.)	337 mm
Covering length on av. approx.	344 mm
Max. gauge (approx.)	350 mm
Tile requirement min. (approx.)	13.7 pcs/m <sup>2</sup>
Average tile requirement (approx.)	14.1 pcs/m <sup>2</sup>
Brickware max. approx.	14.5 pcs/m <sup>2</sup>
Unit weight (approx.)	3.1 kg/piece
Weight per m <sup>2</sup> (approx.)	43.7 kg/m <sup>2</sup>
Weight per pallet (approx.)	769 kg
Pcs per mini-pack	5 piece
Pcs per pallet	240 piece



APPLICATIONS

ADDITIONAL MEASURES ACCORDING TO CREATON MANUFACTURER'S SPECIFICATIONS	
Standard roof pitch CREATON DE in combination with additional measures according to manufacturer's specifications Standard roof pitch CREATON DE in combination with additional measures according to manufacturer's specifications	24 °
Installation of a trussing sheet/glued sub-roof without nail seals, possible CREATON products: DUO extra, DUO longlife ND extra, TRIO extra, QUATTRO longlife extra	≥ 24 °
Installation of a trussing sheet/glued sub-roof without nail seals, possible CREATON products: DUO longlife ND extra	≥ 22 °
Installation of a trussing sheet/glued sub-roof with nail seals, possible CREATON products: DUO extra, DUO longlife ND extra, TRIO extra, QUATTRO longlife extra	≥ 22 °
Installation as a rainproof sub-roof, possible CREATON products: DUO longlife ND extra, TRIO extra, QUATTRO longlife extra	≥ 18 °
Installation as a watertight sub-roof, possible CREATON products: QUATTRO longlife extra	≥ 10 °
Installation as a watertight sub-roof welded in a 7° special solution, please observe separate installation guidelines, possible CREATON products: QUATTRO longlife extra	-

TECHNICAL INFORMATIONS

- The technical drawing shown is merely an example.
- According to the Central Association of the German Roofing Trade (ZVDH) rules for verge tiles, the distance between the inner edge of the verge lug and the outer edge of the gable wall or cladding must be at least 1 cm.
- Current national rules and standards apply to the execution of roofing work. These vary from country to country (e.g. ZVDH Rules, Austrian Standards) and must be taken into consideration during execution. As manufacturer's information, CREATON-specific information about the execution of the sub-roof is also applicable and is complementary to these. You can find them in our Roof Planner or at [www.creaton.de](http://www.creaton.de) / [www.creaton.at](http://www.creaton.at).
- Please consider the sample letter for the standard CREATON roof pitches.



## LAF-/FLA-VALUES

LAF-/FLA VALUES IN MM WITH FALZ FOR 30X50-BATTENS								
requirement ridgetile (approx.)	DN	20°	25°	30°	35°	40°	45°	50°
PRU 2.5 pcs/m	LAF	70	65	60	60	55	50	50
PRU 2.5 pcs/m	FLA	100	90	85	80	65	60	50
PZ 2.5 pcs/m	LAF	70	65	60	60	55	50	50
PZ 2.5 pcs/m	FLA	80	70	65	55	50	45	35

LAF-/FLA VALUES IN MM WITH FALZ FOR 40X60-BATTENS								
requirement ridgetile (approx.)	DN	20°	25°	30°	35°	40°	45°	50°
PRU 2.5 pcs/m	LAF	70	60	55	55	50	40	35
PRU 2.5 pcs/m	FLA	110	100	95	90	75	70	60
PZ 2.5 pcs/m	LAF	70	60	55	55	50	40	35
PZ 2.5 pcs/m	FLA	90	80	75	65	60	55	45

LAF-/FLA VALUES IN MM WITH FALZ FOR 50X50-BATTENS								
requirement ridgetile (approx.)	DN	20°	25°	30°	35°	40°	45°	50°
PRU 2.5 pcs/m	LAF	65	55	50	45	40	30	25
PRU 2.5 pcs/m	FLA	120	110	105	105	90	85	80
PZ 2.5 pcs/m	LAF	65	55	50	45	40	30	25
PZ 2.5 pcs/m	FLA	100	90	85	80	75	70	65



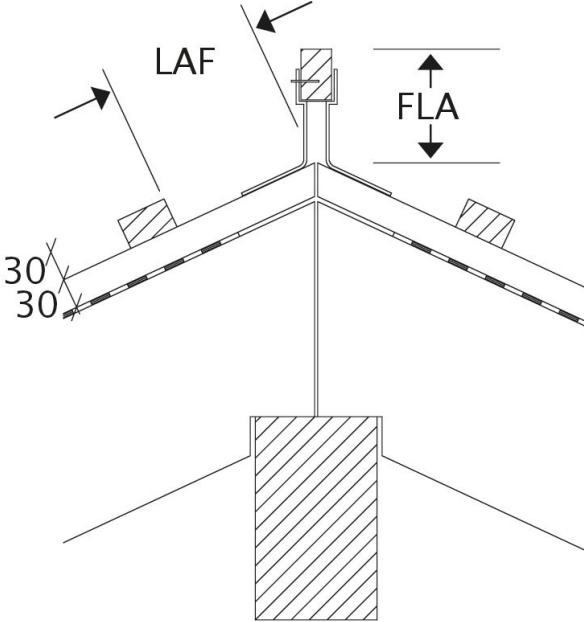

Drawing all models LAF-FLA

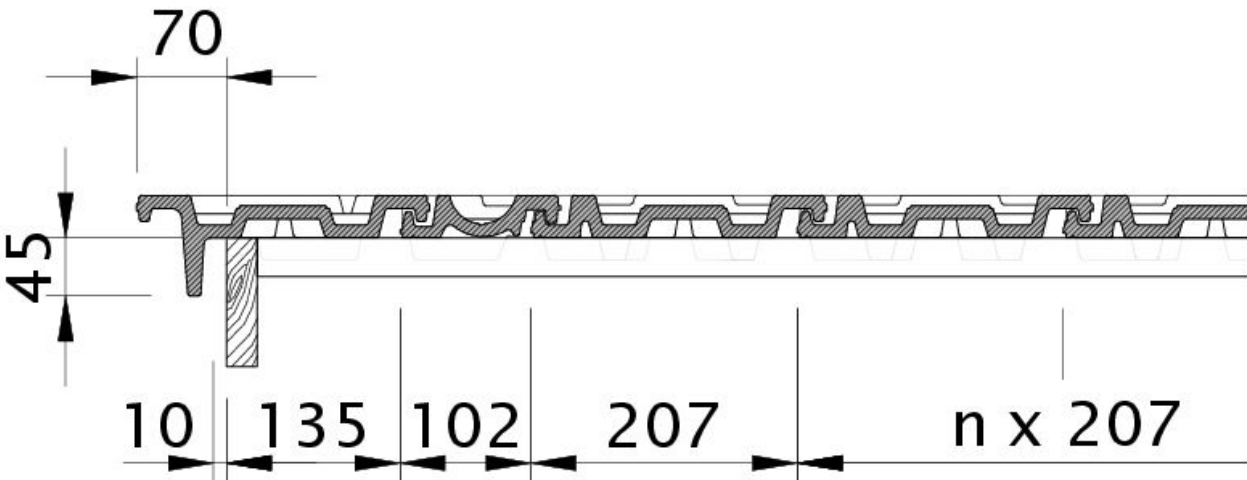

Drawing HERZ verge tile left with barge board OBL



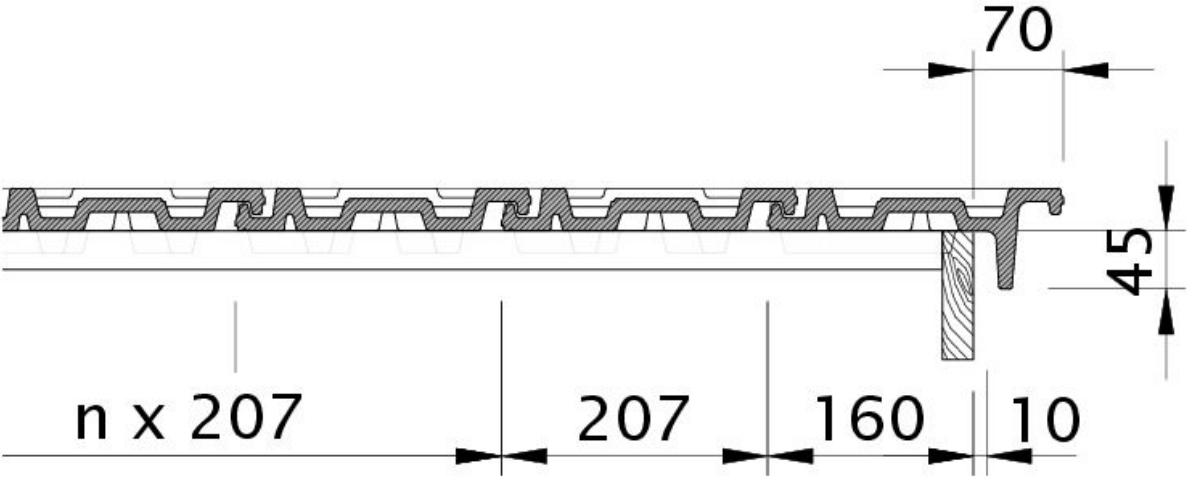

Drawing HERZ verge tile right with barge board OBR

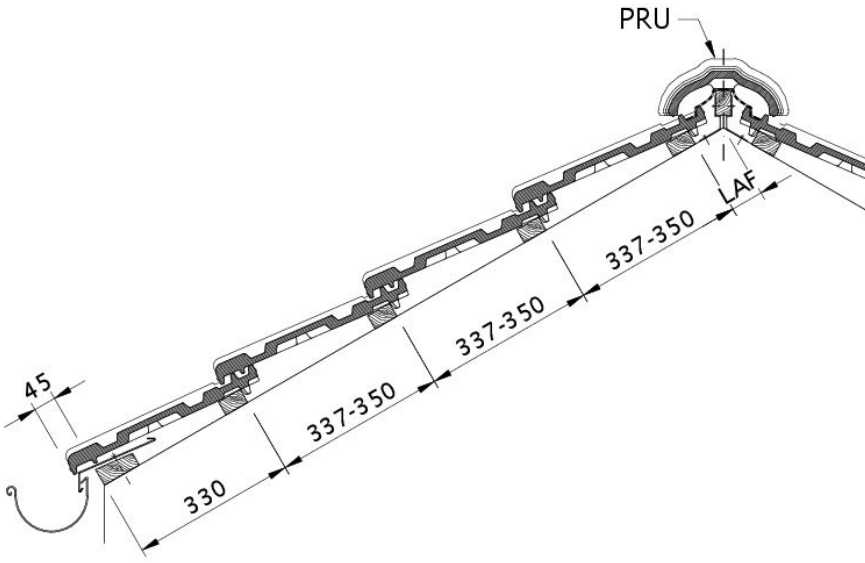

Drawing HERZ roof cross-section DQF



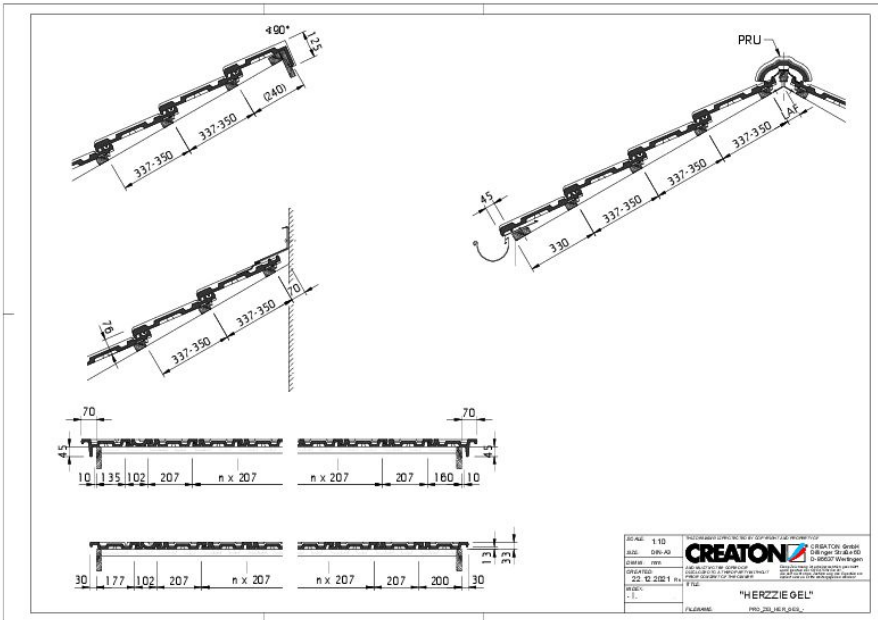

Drawing HERZZIEGEL general view GES

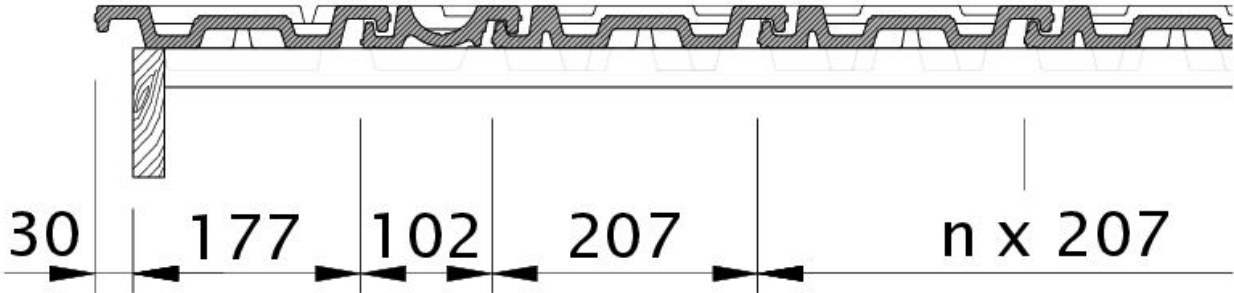

Drawing HERZZIEGEL verge left with verge sheet metal and double roll ODL



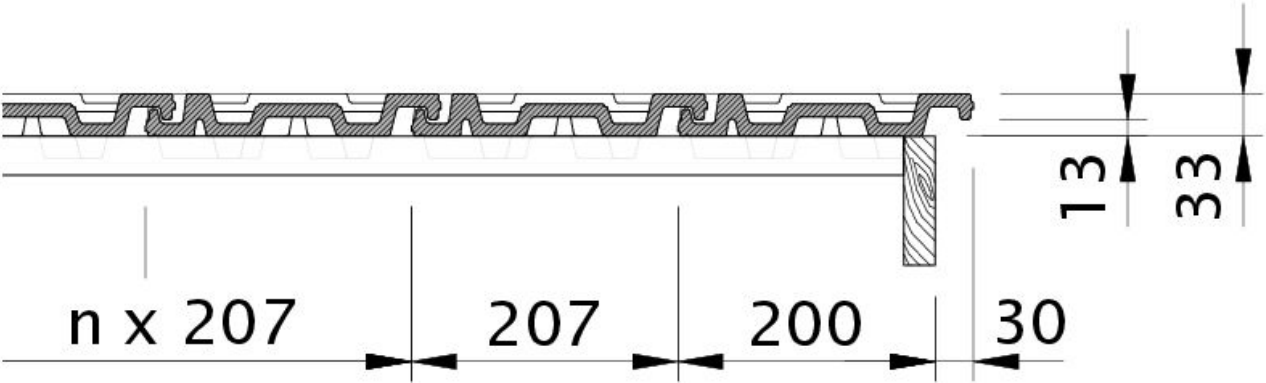

Drawing HERZZIEGEL verge right with verge sheet metal and field tile OFR

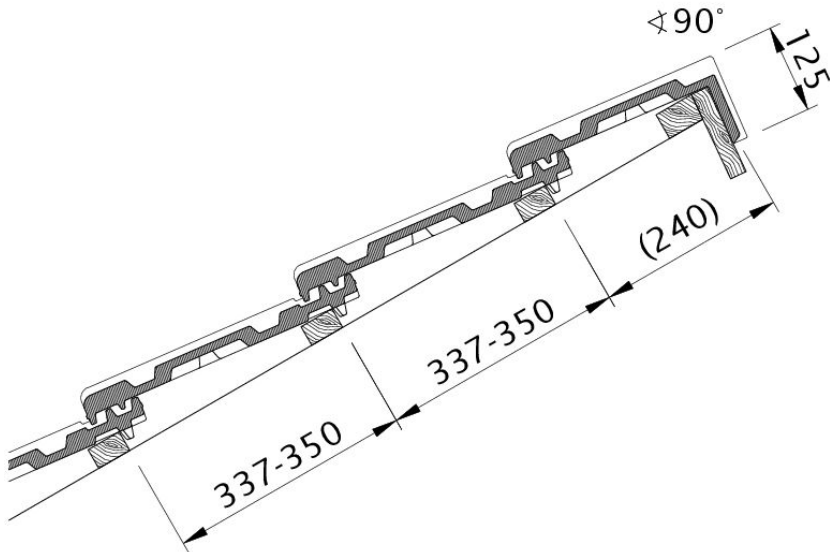

Drawing HERZ shed roof version PDA



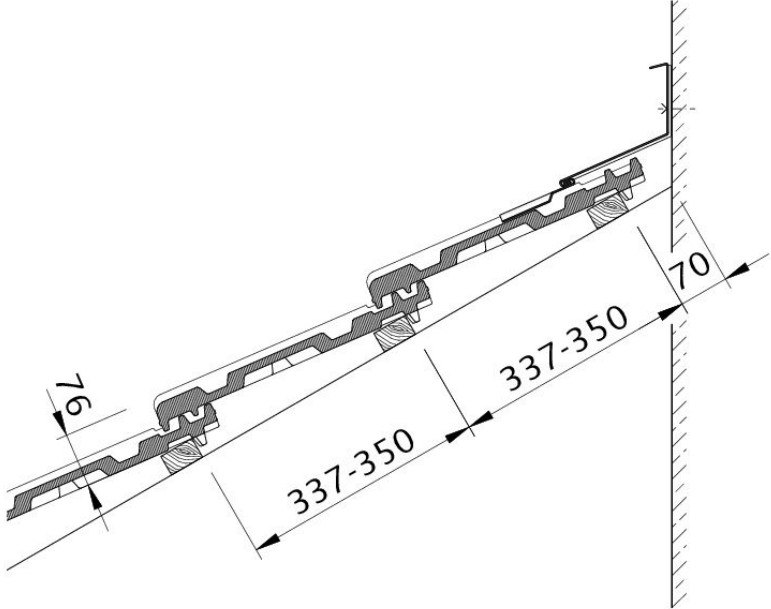

Drawing HERZ wall connection (above) with FALZ WMF

